

Design and Structural Analysis of High Speed Helical Gear Using Ansys

J. Venkatesh*, Mr. P. B. G. S. N. Murthy**

*(PG Student: Department of Mechanical Engineering, Vignan University, Guntur, Andhra Pradesh, India)

** (Associate Professor: Department of Mechanical Engineering, Vignan University, Guntur, Andhra Pradesh, India)

ABSTRACT

In the gear design the bending stress and surface strength of the gear tooth are considered to be one of the main contributors for the failure of the gear in a gear set. Thus, the analysis of stresses has become popular as an area of research on gears to minimize or to reduce the failures and for optimal design of gears. In this paper bending and contact stresses are calculated by using analytical method as well as Finite element analysis. To estimate bending stress modified Lewis beam strength method is used. Pro-e solid modeling software is used to generate the 3-D solid model of helical gear. Ansys software package is used to analyze the bending stress. Contact stresses are calculated by using modified AGMA contact stress method. In this also Pro-e solid modeling software is used to generate contact gear tooth model. Ansys software package is used to analyze the contact stress. Finally these two methods bending and contact stress results are compared with each other.

Keywords –Bending stress, Contact stress, Gear, Helical gear, FE method

I. INTRODUCTION

One of the best methods of transmitting power between the shafts is gears. Gears are mostly used to transmit torque and angular velocity. The rapid development of industries such as vehicle, shipbuilding and aircraft require advanced application of gear technology. Customers prefer cars with highly efficient engine. This needed up a demand for quite power transmission. Automobile sectors are one of the largest manufacturers of gears. Higher reliability and lighter weight gears are necessary to make automobile light in weight as lighter automobiles continue to be in demand.

The best way of transmitting power between the shafts is gears. Gears are mostly used to transmit torque and angular velocity. The design of gear is a complex process. Generally it needs large number of iterations and data sets. In many cases gear design is traditional and specified by different types of standards. B.Venkatesh etc.(1) presented that the stresses were calculated for helical gear by using different materials. Pushpendra Kumar etc. (2) explained about the bending stress for different face width of helical gear calculated by using MATLAB Simulink. Prashanth patil, etc.(3) investigated the 3D photo elastic and finite element analysis of helical gear. Khalish.C (4) focused on Lewis beam strength equation was used to finding out bending strength of a helical gear. Yi-Cheng Chen et al. [5] in their study stress analysis of a helical gear set with localized bearing contact have investigated the contact and the bending stresses of helical gear set with localized

bearing contact by using finite element analysis. S.Vijayaragan and N.Ganesan [6] carried out a static analysis of composite helical gears using three dimensional finite element methods to study the displacements and stresses at various points on a helical gear tooth. For determining the stresses at any stage during the design of gears helix angle and face width are important. Rao and Muthuveerappan [7] have explained the geometry of helical gears by simple mathematical equations. A parametric study was made by varying the face width and the helix angle to study their effect on the root stresses of helical gears.

In helical gears there is a problem of failures at the root of the teeth because of the inadequate bending strength and surface pitting. This can be avoided or minimized by proper method and modification of the different gear parameters. In view of this the main purpose of this work is by using analytical approach and numerical approach to develop theoretical model of helical gear in mesh and to determine the effect of gear tooth stresses.

The main steps involved in this work are described as follow:

- Modeling the gear without losing its geometry in Pro/engineer software.
- Generate the profile of helical gear teeth model to calculate the effect of gear bending, using three-dimensional model and compare the results with modified Lewis theory.
- Develop and determine models of contact elements, to analysis contact stresses using

ANSYS and compare the result with AGMA contact stress equation.

II. MODELING OF GEAR

In this gears are modeled in Pro/ENGINEER Wildfire, which are having the following parameters. The material for the gear is taken as structural steel.

Description	Specifications
Number of teeth	18
Pinion diameter (p) [mm]	344.7
Module(m)mm	18
Pressure angle	20 ⁰
Face width [mm]	420
Addendum [mm]	1m _n
Dedendum [mm]	1.25m _n
Helix angle	20 ⁰
Modulus of Elasticity	2E+05 Mpa
Poisson's Ratio	0.3

The procedure to model the gear of 20 number of teeth with the combination of the all above mentioned parameters in the Pro/ENGINEER Wildfire, other set of gears are modeled in the similar way. Part parameters are the basic parameters defining the gear. These part parameters determine all the other parameters that define the gear tooth profile using the Tools/Relation menu. Figure 1 showing the helical gear generated by Pro/Engineer.

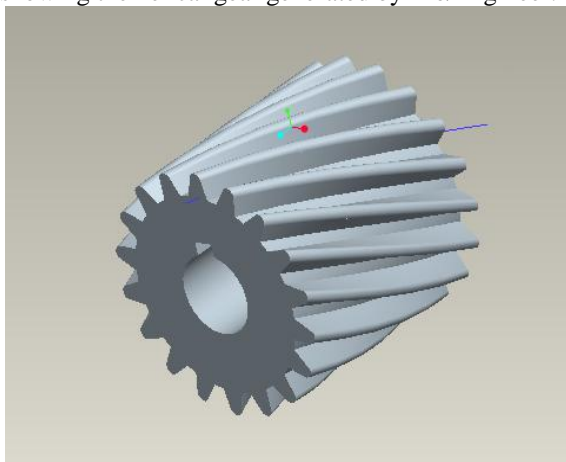

FIG 1 SOLID MODEL OF HELICAL GEAR GENERATED BY PRO/ENGINEER

2.1 FEM Analysis

In this section, the teeth bending stress and contact stresses of helical gear are calculated by using ANSYS. For this purpose the modeled gear in Pro/Engineer is exported to ANSYS as an IGES file and then an automatic mesh is generated. Figure 2

and 3 shows the meshed three-dimensional model. There are more detailed results for various numbers of teeth of helical gear. Which are compared with the result obtained from the AGMA formula.

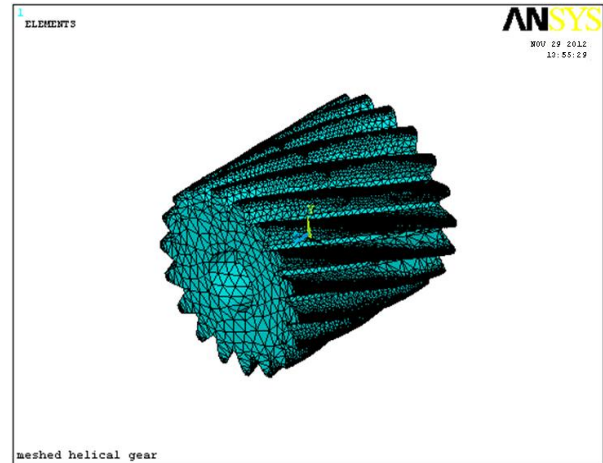

Fig 2 Meshed gear model



Fig 3 Meshing of Contact gear model

III. AGMA EQUATION USED TO CALCULATE BENDING AND CONTACT STRESSES

All the calculations are carried out on the basis of equation recommended by AGMA.

3.1 Bending Stress calculation by using AGMA bendind stress eqn.

$$\sigma_b = \frac{F_t p_d k_o k_s k_m k_v k_B}{b J}$$

$$\sigma_b = \frac{142474 \times 0.0522 \times 1.5 \times 1.25 \times 1.8 \times 1.24 \times 1}{420 \times 0.49}$$

$$= 151.63 \text{ N/mm}^2$$

Bending stress for 20 teeth helical gear

All data same as previous gear but p_d and J values are changed

$$P_d = 20/344.7 = 0.05802$$

From data book

$$J = 0.5$$

$$\sigma_b = \frac{142474 \times 0.05802 \times 1.5 \times 1.25 \times 1.8 \times 1.24 \times 1}{420 \times 0.5}$$

$$= 164.73 \text{ N/mm}^2$$

Bending stress for 25 teeth helical gear

All data same as previous gear but p_d and J values are changed

$$P_d = 25/344.7 = 0.07256$$

$$J = 0.53$$

$$\sigma_b = \frac{142474 \times 0.07256 \times 1.5 \times 1.25 \times 1.8 \times 1.24 \times 1}{420 \times 0.53}$$

$$= 194.35 \text{ N/mm}^2$$

3.2 Contact Stress calculation by using AGMA bending stress eqn.

As already mentioned high contact stresses results in pitting failure of the gear tooth, it is necessary to keep contact stresses under limit. As per AGMA contact stress equation are used as:

$$\sigma_c = C_p \sqrt{\frac{F_t k_o k_v k_s k_m C_f}{D_p b I}}$$

Contact stress for helix angle 15°

$$\sigma_c = 191 \sqrt{\frac{142473.629 \times 1.5 \times 1.25 \times 1.24 \times 1.8 \times 0.56}{420 \times 344.7 \times 0.238}}$$

$$= 594.76 \text{ N/mm}^2$$

Contact stress for helix angle 20°

$$\sigma_c = 191 \sqrt{\frac{142473.629 \times 1.5 \times 1.25 \times 1.24 \times 1.8 \times 0.56}{420 \times 344.7 \times 0.24}}$$

$$= 592.09 \text{ N/mm}^2$$

Contact stress for helix angle 25°

$$\sigma_c = 191 \sqrt{\frac{142473.629 \times 1.5 \times 1.25 \times 1.24 \times 1.8 \times 0.56}{420 \times 344.7 \times 0.242}}$$

$$= 587.28 \text{ N/mm}^2$$

IV. FEM ANALYSIS USED TO CALCULATED THE BENDING AND CONTACT STRESSES

Helical gear assembly was imported in ANSYS 12.1 and the boundary conditions were applied to the gear model. The model was analyzed for the root bending stress for the applied tangential, axial and radial force. In helical gear only 3-D analysis was performed. In this different no of teeth helical gears used to find out the bending stress.

4.1 Bending Stress calculation by using Ansys

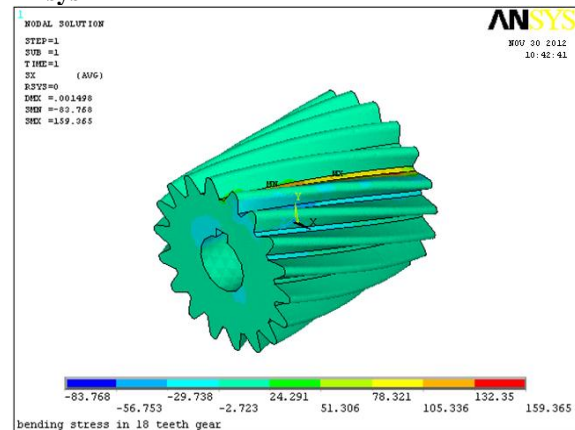

Fig 4. Bending stress of 18 number teeth modeled gear

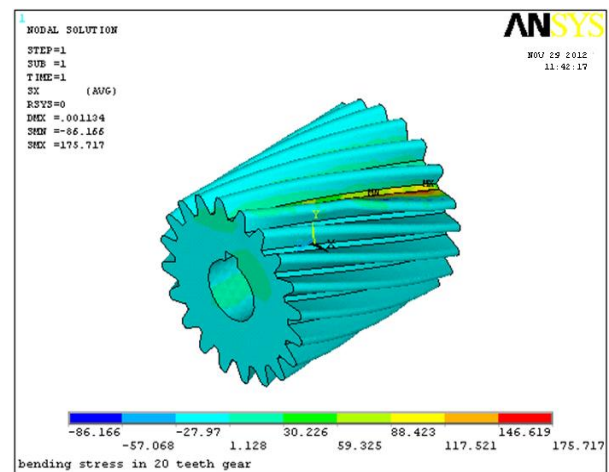

Fig 5. Bending stress of 20 number teeth modeled gear

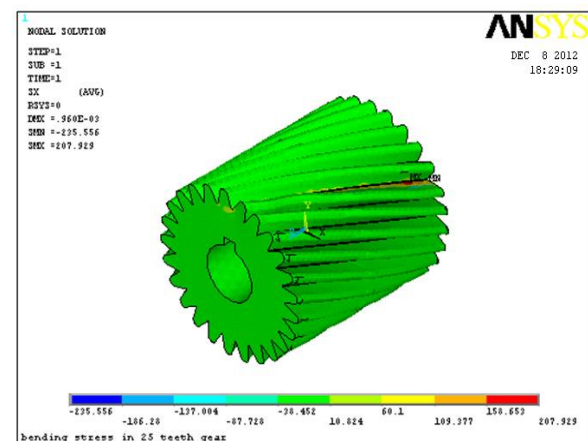

Fig 6. Bending stress of 25 number teeth modeled gear

4.2 Contact Stress calculation by using Ansys

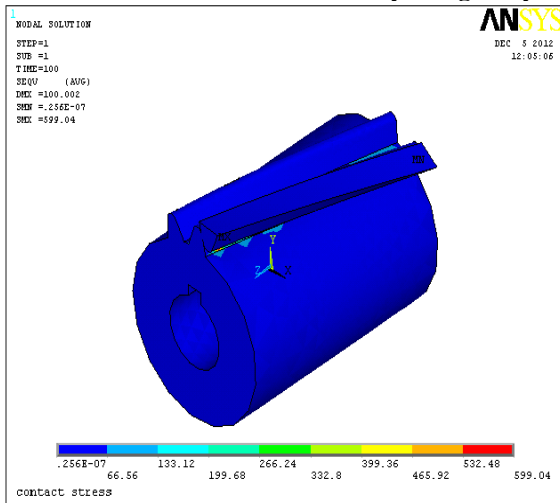

Fig 7. Stress in 15⁰ helical gear contact

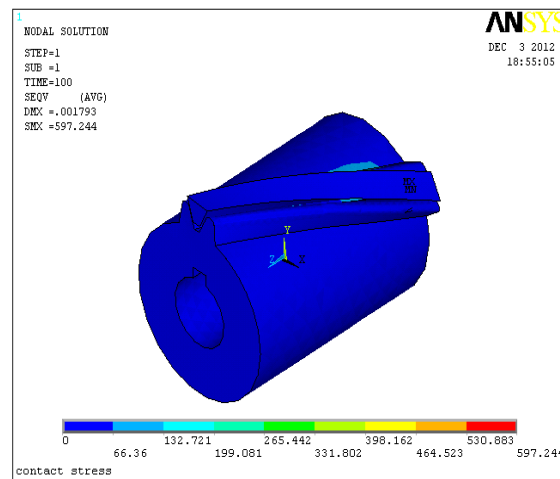

Fig 8. Stress in 20⁰ helical gear contact pair

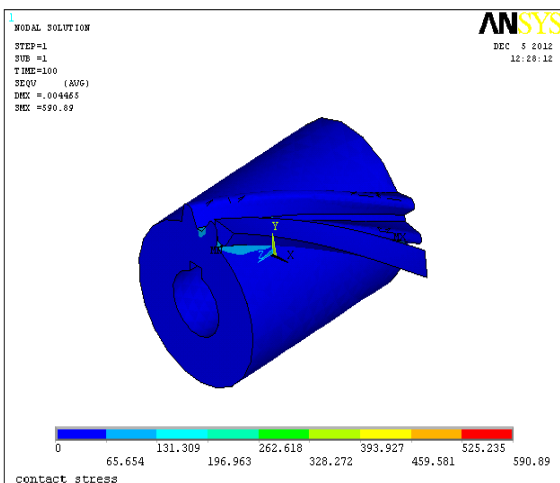
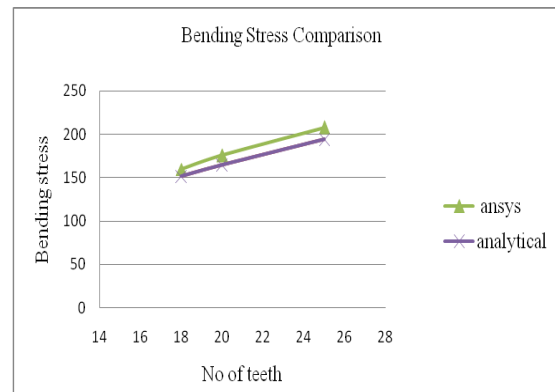
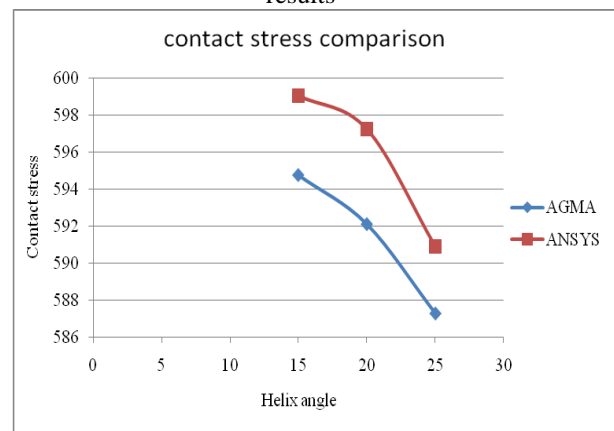

Fig 80. Stress in 25⁰ helical gear contact pair



Graph between AGMA Bending stress and ansys results



Graph between AGMA Contact stress and ansys results

V. CONCLUSION

In this work analytical and Finite Element Analysis methods were used to predicting the Bending and contact stresses of involute helical gear. Bending stresses are calculated by using modified Lewis beam strength equation and Ansys software package. Contact stresses are calculated by using AGMA contact stress equation and Ansys software package.

Comparison of Bending stress results

Number of Teeth	$\sigma_{(AGMA)}$ [MPa]	$\sigma_{(ANSYS)}$ [MPa]	Differences[%]
18	151.63	159.64	5.017
20	164.73	175.71	6.248
25	194.35	207.92	6.526

Comparison of Contact stress results

Helix angle (β) [Degree]	Calculated AGMA contact stress [MPa]	ANSYS value [MPa]	Differences [%]
15	594.73	599.04	0.84
20	592.09	597.24	1.03
25	587.28	590.89	0.67

Error percentage is around 6 % in bending stresses and around 1 % in contact stress analysis. Induced bending stress is a major function of number of teeth and helix angle influence is less on contact stresses. As a result, based on this finding if the material strength value is criterion then a gear with minimum number of teeth with any maximum helix angle of more face width is preferred.

VI. FUTURE SCOPE OF WORK

Recommendation and Future work

The following areas are worthy for further research in the light of this work.

- Three dimensional numerical methods of investigation and study can be conducted on the analysis of bending and contact stresses for all types of gears such as spur, bevel and other tooth forms.
- Numerical method of investigation and study can be conducted on the whole gearbox with all elements in the system including gear casing and bearing.
- Numerical method of investigation and study can be conducted on gears in mesh under dynamic condition with and without cracked teeth, surface pitting or wear.

REFERENCES

[1] B.Venkatesh, V.Kamala, and A.M.K.prasad, Design, modeling and Manufacturing of helical gear, ISSN 0976-4259, 2010.
 [2] Pushpendra kumar, Mishra and Dr.M.S.Murthy, Comparison of Bending stress for Different Face width of helical Gear Obtained Using MATLAB Simulink with AGMA and Ansys , ISSN 2231-5381, 2013.
 [3] Prashant patil, Narayan Dharashiwkar, krishna kumar josh and Mahesh Jadhav, 3D Photo elastic and Finite Element Analysis of Helical Gear, ISSN 1821-1259,2011.
 [4] Khailash C.Bhosale,Analysis of Bending Strength of helical Gear by FEM, ISSN 2222-1727,2011.

[5] Cheng Y, and Tsay C.B, Stress analysis of Helical Gear set with Localized Bearing Contact, Finite Element in Analysis and Design, PP.707-723, 2002.
 [6] Vijayarangan, S, and Ganesan N, A Static Analysis of Composite Helical Gears Using Three-dimensional Finite Element Method, Computers & Structures, PP.253- 268,1993.
 [7] Rao C.M, and Muthuveerappan G, Finite Element Modeling and Stress Analysis of Helical Gear, Teeth, Computers & structures, PP.1095-1106, 1993.
 [8] V.B.Bhandari., Design of Machine Elements, Tmh, 2003.
 [9] R.S.Khurmi., Machine Design, Schand, 2005.
 [10] Krishnaamoorthy, C., Finite Element Analysis Theory and programming, Tata McGraw-Hill, New Delhi, 1994.
 [11] Norton, R.L., Machine Design: An Integrated Approach, New Jersey: prentice-Hall Inc. 1996.
 [12] Shigley, J.E., and Mischke, C.R., Standard Handbook of Machine Design, McGraw-Hill, USA, 1996.